

ArtBin[®]

DESIGNED WITH THE ARTIST IN MIND[™]



VINYL STORAGE RACK™

- Stores up to 12 vinyl rolls
- Includes fasteners for wall mounting
- Peggable poly bag packaging
- Easy snap fit assembly
- 16.46" L x 8.65" W x .95" H



Hang by a peg hole

Ships flat

6864AS
White

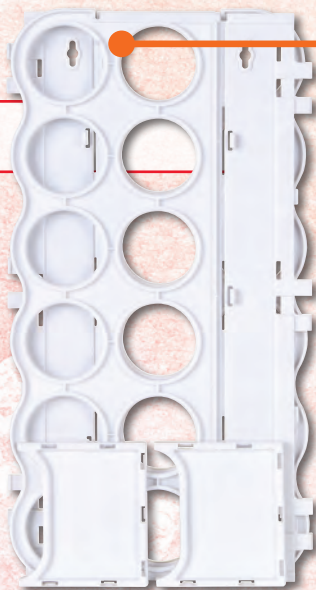

Made In China



New for 2020

DESKTOP ORGANIZER

- Holds a variety of your electronic cutting machine tools and markers
- 24 Slots plus a bulk storage area
- Perfect addition to any desktop



Made In China



6974AG
White



Art side
Craft side



Present what will best
speak to your customer!

VINYL STORAGE TOWER

- Holds up to **36** rolls of vinyl, per tower
- Easy assembly
- Stackable with other 6864XL units
(not recommended stacking more than 2 high)

COMBINE THE **3**
RACKS TO MAKE
THE **TOWER!**

Combine 2 Vinyl
Storage Towers



6864XL
White

Includes 3 Vinyl Storage
Racks and Connectors

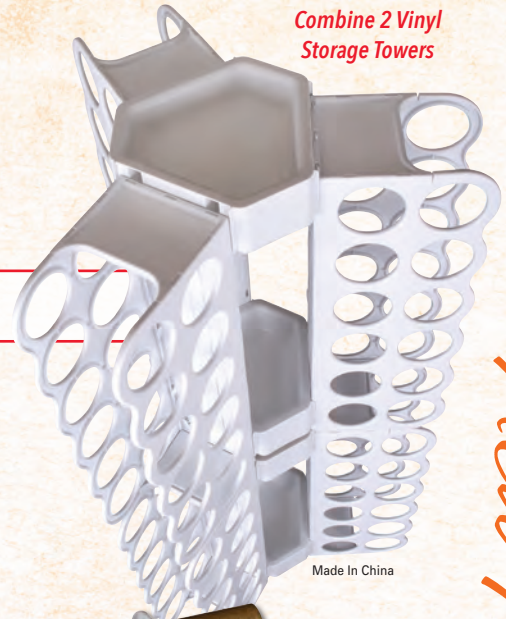

Made In China

The 6864XL can be placed at
shelf in numerous ways!



Shown on the shelf horizontally



Laid flat on the shelf horizontally



Hang by a peg hole



New for 2020



NEW!

6980AG SOLUTIONS™ XL BOX
CLEAR



- 7 Fixed compartments, 9 removable dividers
- 15.25" x 8.875" x 3"



NEW!

6947ZZ PHOTO & CRAFT SUPPLY ORGANIZER SET
CLEAR

- Great for 4" x 6" photos, cards, fabric, embellishments, floss and much more
- 7.5" x 7.2" x 5.2"

New for 2020

NEW!

6899AC DOUBLE DEEP™ WITH TRAY
CLEAR

- Customize from open core up to 8 compartments, plus tray
- 15.25" x 14" x 6.25"

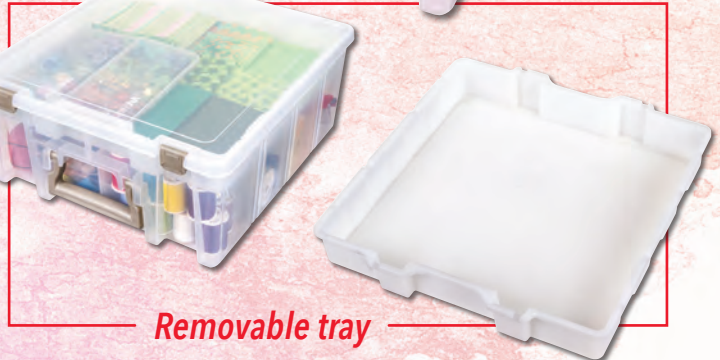

Removable tray

BIN PACKS

- Fits in a Super Satchel™
- Can hang on a peg wall
- Stackable with tight fitting lids



6969AG 3 PACK BINS
Clear Lids and Bases

• 4.25" x 3.25" x 3"



Made in China

Fits into 6965AH

SUPER SACHEL™ WITH CLEAR BINS

- Tight fitting lids for easy transport
- Stackable



6965AH

• Contains 12 short bins



6971AG 4 PACK BINS
Clear Lids and Bases

• 3.12" x 9.82" x 3.02"



Made in China

Fits into 6967AG



6967AG

• Contains 3 short bins and 4 long bins



New for 2020



THE SUPER SATCHEL™ SYSTEM

Sewing today, Paper Crafting tomorrow? No matter your project the Super Satchel™ System has you covered. Works great for Fine Art, Jewelry making or the craft of your choice. At home or on the go with ArtBin®'s Super Satchel Series.

SUPER SATCHEL™ PAPER



SUPER SATCHEL™ SEWING



ANTI-TARNISH



SUPER SATCHEL™ SLIM PAPER



DOUBLE DEEP™ SEWING



DOUBLE DEEP™ WITH TRAY



DOUBLE DEEP™ WITH PAINT STORAGE TRAY



SEMI SATCHEL™ SEWING



SEMI SATCHEL™ MARKER STORAGE 2 TRAY



SUPER SATCHEL™ WITH REMOVABLE BINS



SUPER SATCHEL™ WITH BOTTLE STORAGE TRAY



THREAD BOX



SUPER SATCHEL™ DOUBLE DEEP WITH THREAD TRAY



ROLLING TOTE



CUBE W/ DIFFERENT SATCHELS



SEMI SATCHEL™

- Great for card stock, punches and tools of the trade!
- Compatible with ArtBin® accessories: **6826AG**, **6828AG**, **6939AB** and **6951AB**
- 3 Removable dividers to customize space
- 15.25" x 8" x 6.25"



SUPER SATCHEL™ Standard

- Easily organize papers and projects up to 12" x 12"
- Fits 12" x 12" pad
- Compatible with ArtBin® accessories: **6820AG**, **6951AB**, **6965AH** and **6967AG**
- 15.25" x 14" x 3.5"



Super Satchel System



Super Satchel™ boxes are designed to stack together.



Fits in the Super Satchel™ Cube

DOUBLE DEEP™

- Use "Open Core" (*without dividers*) or customize up to 8 compartments for flexibility
- Compatible with ArtBin® accessories: **6826AG, 6828AG, 6901AB, 6939AB** and **6951AB**
- **Acid-Free** and size: 15.25" x 14" x 6.25"

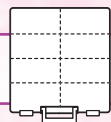

6990AB
Removable Dividers, Clear



6990AA
Aqua Mist



6990RK
Rose Gold Handle & Latches



6990RH
Aqua Mist Handle & Latches



6899AC **DOUBLE DEEP™ WITH TRAY**
CLEAR

- Customize from open core up to 8 compartments, plus tray
- **Acid-Free**
- 15.25" x 14" x 6.25"



Made In China

6855SC **SUPER SATCHEL™ CUBE**
White

- Each Super Satchel Cube™ comes with 6 sets of rails which allows you to store Slim, Standard & Double Deep™ Super Satchel™ boxes (**boxes not included**)
- Interior walls are pre-drilled with a series of holes to allow customization of rail height
- Assembly required, 15.5" x 16.75" x 15.625"

6856SW **CUBE CASTERS**



A SET OF 4 CASTERS SUPPORTS A TOTAL WEIGHT OF 225 LBS. (INCLUDING CUBE AND SUPPLIES)



Removable tray

Super Satchel System



Fits in the Super Satchel™ Cube

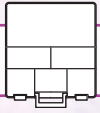

9001AB SUPER SACHEL™
Standard - Divided, Clear

- 6 Fixed divided compartments
- 15.25" x 14" x 3.5"



9100AB SUPER SACHEL™
Slim - 1 Compartment, Clear

- Excellent for storing papers, pages, die cuts, stickers and mats
- 15.25" x 14" x 2"

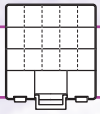

9007AB SUPER SACHEL™
Standard - Removable Dividers, Clear

- 6 Fixed compartments and 12 removable dividers make custom storage possibilities for any number of supplies
- 15.25" x 14" x 3.5"

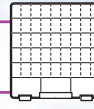

9101AB SUPER SACHEL™
Slim - Removable Dividers, Clear

- 8 Fixed compartments and 20 removable dividers
- Excellent for storing eyelets, punches, trims, brads, ribbon, small stamps and pads
- 15.25" x 14" x 2"



6967AG SUPER SACHEL™ WITH BINS
Clear lids and Bases

- Tight fitting lids for easy transport
- Stackable
- 15.25" x 14" x 3.5"



6965AH SUPER SACHEL™ WITH BINS
Clear lids and Bases

- Tight fitting lids for easy transport
- Stackable
- 15.25" x 14" x 3.5"



Also available with opaque bins (not shown)

6965AG SUPER SACHEL™ WITH BINS
Clear Lids, Opaque Bases



6971AG 4 PACK BINS
Clear Lids and Bases

- Fits in a Super Satchel™
- Can hang on a peg wall
- Stackable with tight fitting lids
- 3.12" x 9.82" x 3.02"



Made in China



6969AG 3 PACK BINS
Clear Lids and Bases

- Fits in a Super Satchel™
- Can hang on a peg wall
- Stackable with tight fitting lids
- 4.25" x 3.25" x 3"



Made in China

Super Satchel System

SUPER SACHEL™ SYSTEM ACCESSORIES



6820AG THREAD STORAGE TRAY
White

- Holds 21 spools of thread
- Sturdy and stylish construction
- Wall mountable

2 Fit inside Super Satchel™ 6955AB and
1 in Super Satchel™ Semi 6925AB!



Scissor hole



6826AG RIBBON STORAGE TRAY
White

- Holds ribbon, trims and tape
- Sturdy and stylish construction
- Wall mountable

2 Fit inside Super Satchel™ 6955AB and
1 in Super Satchel™ Semi 6925AB!

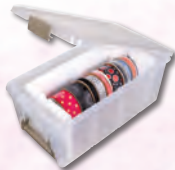

6828AG PAINT STORAGE TRAY
White

- (21) 1.5" Square openings to hold a variety of supplies
- Openings are perfectly sized to hold 4 oz. paint bottles
- Wall mountable

2 Fit inside Super Satchel™ Double Deep™
6990AB & 1 in Super Satchel™ Semi 6925AB!



6901AB CONE THREAD TRAY
White

- Sturdy base with easy to insert "prongs" holds a minimum of 25 and up to 50 cone thread spools

Fits inside Super Satchel™
Double Deep™ 6990AB



6939AB MARKER STORAGE TRAY
White

- 1 Tray holds up to 64 markers/pens
- Optional hooks for use in 6990AB

Fits inside Marker Storage Satchel™
6934AB, 4 fit in the Super Satchel™
Double Deep™ 6990AB and 2 fit in
the Super Satchel™ Semi 6925AB!

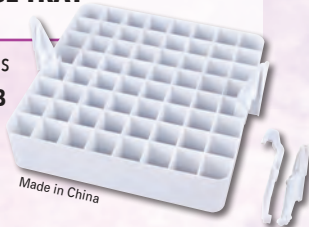

6951AB BOTTLE STORAGE TRAY
White

- Each tray holds (32) .5 oz. bottles
- Bottle Tray contains a "kickstand" to make bottle selection easier

Fits 2 inside Super Satchel™ 6955AB and 1 in
Super Satchel™ Semi 6925AB!



Super Satchel System

Detachable Shoulder Bag



6922SA TOTE EXPRESS™
Black and Gray

Complete unit: 18" x 13" x 30.5"

Top Unit: 18" x 13" x 16.25"

- 26 Individual loops on inside cover for markers, brushes, etc.
- Large back pocket holds up to 12" x 12" books, papers & projects
- Shoulder strap w/shoulder pad to transport the top unit separately

Bottom Unit: 18" x 13" x 14.25"

- Large, open base easily accommodates bulkier supplies
- Solid wall inserts in both top and bottom units
- Double reinforced side handles for secure lifting of bottom unit
- Transport with locking 2 stage handle and sturdy double skate wheels



Made in China

All boxes shown sold separately

6822AG ARTBIN® ROLLING TOTE
Gray Pattern

- Collapsible tote with carrying handles
- Retractable handle extends to 34.5" from the ground
- Constructed of durable, fashionable, weather resistant poly canvas
- Lightweight (under 3.5 lbs.)
- 18" x 13.75" x 13.75"



2 Mesh pockets on the back

Completely collapsible

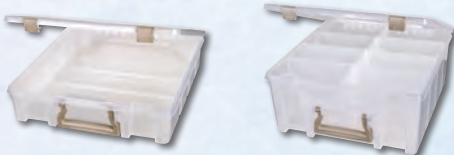

Sized to hold all Super Satchel™ Standard, Slim, Double Deep™, Semi Satchel™ and small storage boxes

6822AJ ARTBIN® ROLLING TOTE 3 PACK

- PDQ included
- 13.5" x 14.5" x 18.5"



Made in China

Super Satchel System

QUICK VIEW™ CARRYING CASES

- All are **Acid-Free** and translucent for easy viewing of supplies
- Secure sliding, lockable latches with easy grip, molded-in handles
- (8) Styles for a variety of storage applications

Carrying Cases - **DEEP BASE**

10"

6972AB **ONE COMPARTMENT**
Clear

- 10.25" x 3.25" x 9.625"



12"

6977AB **ONE COMPARTMENT**
Clear

- 12" x 3.625" x 9.75"



15"

6960AB **ONE COMPARTMENT**
Clear

- 15" x 3.5" x 14.5"



Carrying Cases - DEEP BASE

15"

6961AB DIVIDED COMPARTMENT
Clear

- Fixed compartments, 12 removable dividers
- Lid securely locks over divided areas to prevent migration
- 15" x 3.5" x 14.5"



15"

6962AB DIVIDED BASE W/LIFT-OUT TRAY
Clear

- Lift-out tray custom designed to fit over divided base to prevent migration of supplies
- Lower level has fixed compartments, 16 removable dividers
- 15" x 3.5" x 14.5"



Carrying Cases - STANDARD BASE



10.5"

8010AB 1 COMPARTMENT
Clear

- 10.5" x 3.125" x 8.375"



14"

8014AB 1 COMPARTMENT
Clear

- 14" x 3.375" x 10.25"



17"

8017AB 1 COMPARTMENT
Clear

- 17" x 3.875" x 12.375"

Storage Necessities

QUICK VIEW™ WITH REMOVABLE BINS

- Removable bins ideal for the storage of small supplies
- Lid design locks bins in place when closed, no migration of supplies
- Heavy duty handle and latches designed for portability



6873AG QUICK VIEW™ WITH REMOVABLE BINS

- 15 Removable bins
- 8.125" x 13" x 2.375"



6874AG QUICK VIEW™ WITH REMOVABLE BINS

- 13 Removable bins
- 16.5" x 13" x 2.5"



6877AG DOUBLE-SIDED QUICK VIEW™ WITH REMOVABLE DIVIDERS

- 22 Compartments and 18 removable dividers
- 12.5" x 10.25" x 3.25"



6876AG QUICK VIEW™ WITH REMOVABLE DIVIDERS

- 22 Compartments and 18 removable dividers
- 12.5" x 10.5" x 2.25"



6816AG SIDEKICK™ CUBE WITH PAINT PALETTE TRAY *Clear*

- Paint Palette Tray included
- 2 Removable dividers
- Perfect for storing water-color, acrylic and oil paints
- 11.2" x 7.87" x 5.57"



Tray made in China



Comes 2 in a Pack!

Made In China

6833AG PAINT STORAGE PALETTES *White*



6815AG MINI SIDEKICK™ *Clear*

- Great bulk storage box for supplies
- Supplies easily visible
- Lockable
- 11" x 5.5" x 7"



6817AG SIDEKICK™ CUBE WITH OPEN TRAY *Clear*

- White plastic tray included
- 2 Removable dividers
- 11.2" x 7.87" x 5.57"



Tray made in China

8408AB SIDEKICK™ *Clear*

- Secure latch with side opening lid
- Additional storage in top of lid
- Lift-out tray
- Generous bulk storage beneath tray
- 15" x 10" x 7.75"



Storage Necessities

LIFT-OUT TRAY BOXES

- 2 Level storage in a clear **Acid-Free** box and tray
- Comfort grip handle with matching latches!



83805 LIFT-OUT TRAY BOX
Black Handle and Latches

• 13" x 6" x 5.625"



6890AG SMALL PROJECT BOX
Clear

- Lift-out tray for small items
- Great compact size for small projects and children
- 9" x 5.5" x 6.75"



6918AH 17" TWIN TOP
Clear

- Lift-out tray holds smaller items
- Additional compartments in lid store small items
- Sturdy lockable latch keeps supplies secure
- 17" x 8.5" x 8.5"

17"



6966AB LIFT-OUT TRAY BOX
Black Handle and Latches

• 16.25" x 8.25" x 7"

16"



14" Is also available: **6965AB**



Storage Necessities

SLIM LINE™ 4 X 4 BOXES - 2 PACK

6900AG

6906AG

6910AG

- Constructed with crystal clear impact resistant styrene
- Slim design easily fits in totes, pockets and other ArtBin® products
- 4.25" x 3.75" x .625"



6907AB 10 COMPARTMENT Clear

- 7.375" x 3.625" x .6875"



PRISM™ SERIES BOXES

- Crystal clear Prism™ boxes offer easy viewing of supplies
- Great for markers, pencils and frequently used art supplies
- Versatile assortment of sizes and inside cores

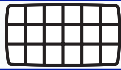

918AB Clear

- 18 Fixed compartments
- 8.875" x 4.875" x 1.375"



1106AB Clear

- 6 Fixed compartments
- 11.5" x 6.625" x 1.75"



1100AB Clear

- 1 Compartment
- 11.5" x 6.625" x 1.75"



1118AB Clear

- 18 Fixed compartments
- 11.5" x 6.625" x 1.75"



Storage Necessities

- SOLUTIONS™ BOXES**
- Clear **Acid-Free** shatterproof boxes have no-spill latches & sturdy hinges
 - High-impact plastic is resistant to oils, solvents & most common chemicals
 - Includes dividers for additional compartment capabilities

Storage Necessities



2003AB
Clear

- 3 Fixed compartments, 15 removable dividers
- 7" x 4" x 1.5"



3003AB
Clear

- 3 Fixed compartments, 15 removable dividers
- 9.125" x 5" x 1.375"

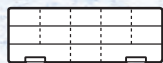

3900AB
Clear

- 3 Fixed compartments, 9 removable dividers
- 12.38" x 4.875" x 1.75"



4000AB
Clear

- 1 Compartment
- 10.75" x 7.375" x 1.75"



Fits in the
Solutions™ Cabinets
(Pgs 22, 35, 43, 54)



Large side
compartment

4004AB
Clear

- 4 Fixed compartments, 12 removable dividers
- 10.75" x 7.375" x 1.75"



4006AB
Clear

- 6 Fixed compartments, 12 removable dividers
- 10.75" x 7.375" x 1.75"





5004AB
Clear

- 4 Fixed compartments, 20 removable dividers
- 14.125" x 9" x 2"



6980AG SOLUTIONS™ XL BOX
CLEAR

- 7 Fixed compartments, 9 removable dividers
- 15.25" x 8.875" x 3"

IDS™ BOXES

- Infinite Divider System™ adjusts in 1/16" increments - no wasted space!
- Clear **Acid-Free** shatterproof boxes have no-spill latches and sturdy hinges
- High-impact plastic resists solvents, oils and most common chemicals

6108DP IDS DIVIDERS

- 8 Per pack
- For use in 600IDS box

9108DP IDS DIVIDERS

- 8 Per pack
- For use in 900IDS and 6910AB IDS™ boxes



600IDS
Clear

- 6 Fixed compartments, 6 removable IDS™ dividers
- 11" x 6.75" x 1.75"



900IDS
Clear

- 4 Fixed compartments, 8 removable IDS™ dividers
- 13.625" x 9.5" x 2"

Storage Necessities

BIN PACKS

- Fits in a Super Satchel™
- Can hang on a peg wall
- Stackable with tight fitting lids



6969AG 3 PACK BINS Clear Lids and Bases

- 4.25" x 3.25" x 3"



Made in China



6971AG 4 PACK BINS Clear Lids and Bases

- 3.12" x 9.82" x 3.02"



Made in China



SUPER SATCHEL™ WITH CLEAR BINS



6965AH Clear lids and Bases

- Contains 12 short bins
- 15.25" x 14" x 3.5"



Also available with
opaque bins 6965AG



6967AG Clear lids and Bases

- Contains 3 short and
4 long bins
- 15.25" x 14" x 3.5"



6946AB 4" X 6" PHOTO AND SUPPLY BOX Clear

- Acid-Free
- Holds up to (100) 4 x 6 photos!
- 6.625" x 4.75" x 1.125"



6947ZZ PHOTO & CRAFT SUPPLY ORGANIZER SET CLEAR

- Great for 4" x 6" photos, cards, fabric, embellishments, floss and much more
- 7.5" x 7.2" x 5.2"



TWISTERZ™

- Twist to close lids
- Stack and lock design
- Also fits inside **Super Satchel™** boxes!



All Twisterz Made in China

6940AB

1.4 fl oz./41.4 ml.
Small/Short



6942AB

3.9 fl oz./115.3 ml.
Large/Short



6941AB

3.4 fl oz./100.5 ml.
Small/Tall

6943AB

9 fl oz./266.1 ml.
Large/Tall

Also available in Packs!

TWISTERZ™ 3 PACKS

All Twisterz Made in China



6940AD
Clear

1.4 fl oz./41.4 ml.
Small/Short



6942AD
Clear

3.9 fl oz./115.3 ml.
Large/Short



6941AD
Clear

3.4 fl oz./100.5 ml.
Small/Tall



6943AD
Clear

9 fl oz./266.1 ml.
Large/Tall

Storage Necessities



6958AC **SLIME BOX**
Clear

- Box keeps the goo *SLIMY!*
- Simple friction lid
- 4.5 Dia. x .875" H

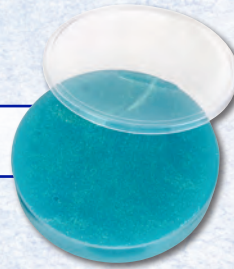

Storage Necessities

SOLUTIONS™ CABINETS

- Space efficient cabinet comes with (2) **3900AB** Divided and (1) **3901AB** Open Core Solutions™ boxes!
- Secure front "door" holds boxes in place
- Additional space in lid for supplies or will hold up to 2 additional Solutions boxes (sold separately)
- Secure latch on lid and comfort grip handle
- 14.5" x 6.5" x 10.5"



6994AA
Aqua Mist

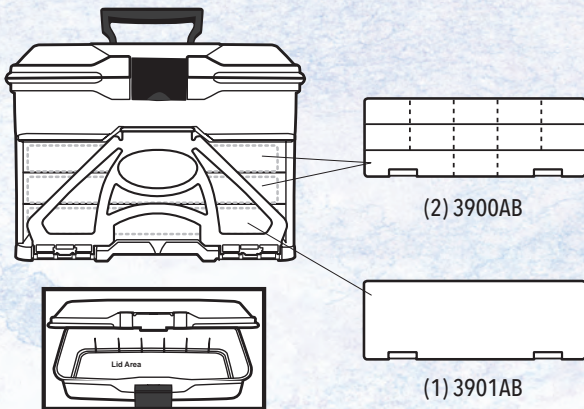

6994AB
White

DELUXE SERIES: THE ULTIMATE STORAGE UNIT!

- Lid and base each have separate access
- (2) Side bins with dividers allow for multiple storage options
- **Acid-Free** and stackable!
- 17.25" x 16.75" x 5"

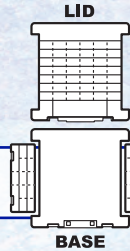

6981AB **DIVIDED LID /**
1 COMPARTMENT BASE Clear

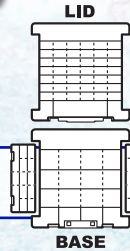

6982AB **DIVIDED LID /**
DIVIDED BASE Clear



12" X 12" STORAGE BOXES

- **Acid-Free** and stackable!
- (2) Integrated front latches securely keep lid closed
- Rounded corners prevent paper edges from damage
- Slightly raised internal base for ease of content removal
- 14.125" x 13.625" x 3"

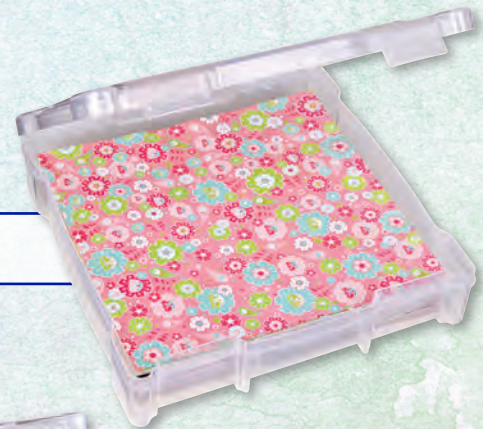

6912AB
Clear with Grip Area



6913AB
Clear with Handle

Storage Necessities

6864AS VINYL STORAGE RACK White

- Stores 12 vinyl rolls
- Includes fasteners for wall mounting
- Peggable poly bag packaging
- Easy snap fit assembly
- 16.46" L x 8.65" W x .95" H

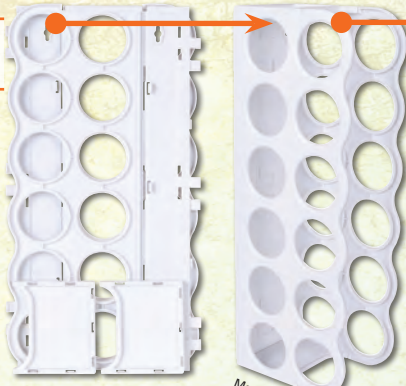

Ships flat

Made In China



COMBINE THE **3**
RACKS TO MAKE
THE **TOWER!**

*Includes 3 Vinyl Storage
Racks and Connectors*

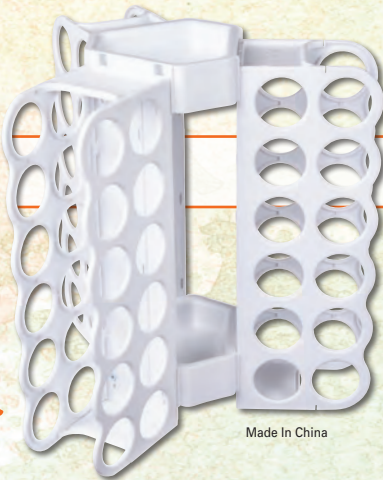

Made In China



6864XL VINYL STORAGE TOWER White

- Holds up to **36** rolls of vinyl, per tower
- Easy assembly
- Stackable with other 6864XL units
(not recommended stacking more than 2 high)



Combine 2 Vinyl Storage Towers



6974AG DESKTOP ORGANIZER White

- Holds a variety of your electronic cutting machine tools and markers
- 24 Slots plus a bulk storage area
- Perfect addition to your desktop



Made In China



SEMI SACHEL™

- Great for card stock, punches and tools of the trade!
- Compatible with ArtBin® accessories: **6826AG**, **6828AG**, **6939AB** and **6951AB**
- 3 Removable dividers to customize space
- 15.25" x 8" x 6.25"

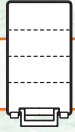

6925AB
 Removable Dividers, Clear



6925AA
 Aqua Mist Handle & Latch



SUPER SACHEL™ Standard

- Easily organize papers, pages and projects up to 12" x 12"
- Compatible with ArtBin® accessories: **6820AG** and **6951AB**
- 15.25" x 14" x 3.5"



Fits in the
 Super Satchel™ Cube



Super Satchel™
 boxes are designed
 to stack together.

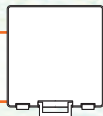

6955AB
 1 Compartment, Clear



6955AA
 Aqua Mist



6955RK
 Blush



6955RJ
 Mint

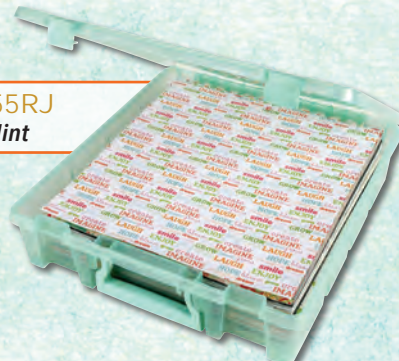

Paper Crafting



Super Satchel™ boxes are designed to stack together.



Fits in the Super Satchel™ Cube

DOUBLE DEEP™

- Use "Open Core" (*without dividers*) for paper and albums or customize up to 8 compartments for multiple storage options including card making supplies, dies, templates, punches and more!
- Compatible with ArtBin® accessories: **6826AG, 6828AG, 6901AB, 6939AB** and **6951AB**
- **Acid-Free** and size: 15.25" x 14" x 6.25"

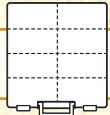

6990AB
Clear



6990AA
Aqua Mist



6990RK
Rose Gold Handle & Latches



6990RH
Aqua Mist Handle & Latches



Removable tray



Removable tray



6899AC **DOUBLE DEEP™ WITH TRAY**
CLEAR

- Customize from open core up to 8 compartments, plus tray
- 15.25" x 14" x 6.25"



Paper Crafting



Fits in the
Super Satchel™ Cube



9001AB SUPER SATCHEL™
Standard - Divided, Clear

- 6 Fixed divided compartments
- 15.25" x 14" x 3.5"



9100AB SUPER SATCHEL™
Slim - 1 Compartment, Clear

- Excellent for storing papers, pages, die cuts, stickers and mats
- 15.25" x 14" x 2"



9007AB SUPER SATCHEL™
Standard - Removable Dividers, Clear

- 6 Fixed compartments and 12 removable dividers make custom storage possibilities for any number of supplies
- 15.25" x 14" x 3.5"



9101AB SUPER SATCHEL™
Slim - Removable Dividers, Clear

- 8 Fixed compartments and 20 removable dividers
- Excellent for storing eyelets, punches, trims, brads, ribbon, small stamps and pads
- 15.25" x 14" x 2"



Made in China

6855SC SUPER SATCHEL™ CUBE
White

CUSTOMIZE WITH ANY FULL SIZE SUPER SATCHEL™ BOXES



- Each Super Satchel Cube™ comes with 6 sets of rails which allows you to store Slim, Standard, and Double Deep™ Super Satchel™ boxes (**boxes not included**)
- Interior walls are pre-drilled with a series of holes to allow customization of rail heights
- Assembly required; box size: 15.5" x 16.75" x 15.625"



6856SW CUBE CASTERS



A SET OF 4 CASTERS SUPPORTS A TOTAL WEIGHT OF 225 LBS. (INCLUDING CUBE AND SUPPLIES)

SUPER SACHEL™ SYSTEM ACCESSORIES



6828AG PAINT STORAGE TRAY
White

- (21) 1.5" Square openings to hold a variety of supplies
- Openings are perfectly sized to hold 4 oz. paint bottles
- Wall mountable

Fits 2 inside Super Satchel™ Double Deep™ 6990AB and 1 in Super Satchel™ Semi 6925AB!



Scissor hole



6826AG RIBBON STORAGE TRAY
White

- Holds ribbon, trims and tape
- Sturdy and stylish construction
- Wall mountable

Fits 2 inside Super Satchel™ 6990AB and 1 in Super Satchel™ Semi 6925AB!



6939AB MARKER STORAGE TRAY
White

- 1 Tray holds up to 64 markers/pens
- Optional hooks for use in **6990AB**

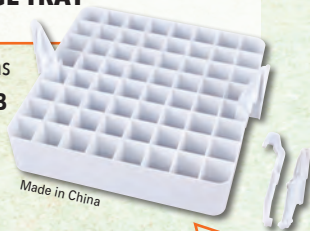

Fits inside Marker Storage Satchel™ 6934AB, 4 fit in the Super Satchel™ Double Deep™ 6990AB and 2 fit in the Super Satchel™ Semi 6925AB!



6934AB SUPER SACHEL™ SERIES MARKER STORAGE Clear

- **Acid-Free** and stackable!
- Tray holds up to 64 markers/pens
- Additional trays available (**6939AB**)
- 15.25" x 8" x 6.25"

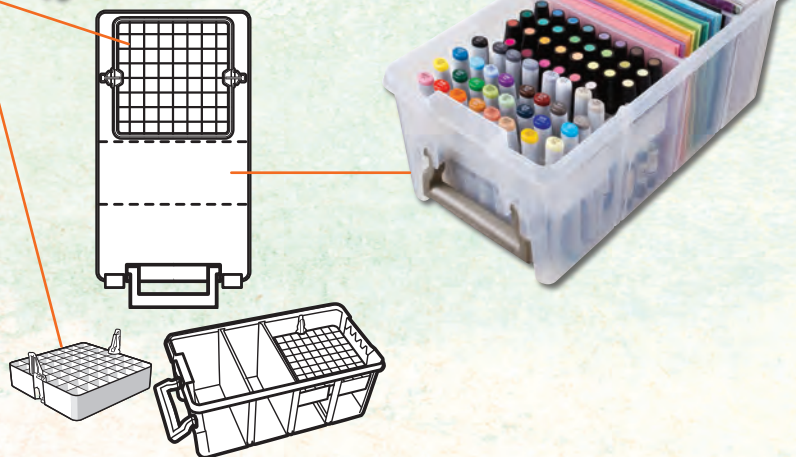

Paper Crafting

— SUPER SATCHEL™ SYSTEM ACCESSORIES —

6951AB BOTTLE STORAGE TRAY White

- Each tray holds (32) .5 oz. bottles
- Bottle Tray contains a "kickstand" for desktop use



Fits 2 inside Bottle Storage Satchel™ 6959AB and 1 in Super Satchel™ Semi 6925AB!

6959AB BOTTLE STORAGE SATCHEL™ Clear with White Trays

- Contains 2 trays in 6955AB Super Satchel™



6978AB MAGNETIC DIE STORAGE CASE Clear

- Magnetic sheets securely hold dies for easy viewing and safe storage
- Comes with 3 Magnetic sheets
- Filled case will hold approximately 15 total sheets
- 10.25" x 3.25" x 9.625"



6979AB MAGNETIC DIE SHEETS SET White

- Includes 3 die cut magnetic sheets
- Fits in 6978AB
- 7.0625" x 8.9375" x .0625"



6945AB ELECTRONIC CARTRIDGE STORAGE Clear with White Trays

- 2 Removable trays conveniently store up to 16 cartridges, booklets and tools!
- Stackable with all Slim, Standard, and Double Deep™ Super Satchel™ models
- 15.25" x 14" x 2"

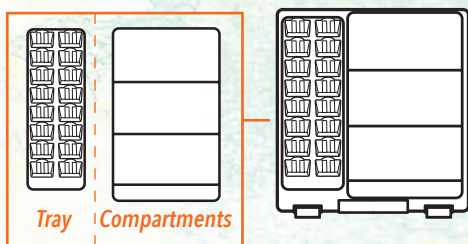

Paper Crafting

6922SA TOTE EXPRESS™ Black and Gray

Complete unit: 18" x 13" x 30.5"

Top Unit: 18" x 13" x 16.25"

- 26 Individual loops on inside cover for markers, brushes, etc.
- Large back pocket holds up to 12" x 12" books, papers & projects
- Shoulder strap w/shoulder pad to transport the top unit separately

Bottom Unit: 18" x 13" x 14.25"

- Large, open base easily accommodates bulkier supplies
- Solid wall inserts in both top and bottom units
- Double reinforced side handles for secure lifting of bottom unit
- Transport with locking 2 stage handle and sturdy double skate wheels



Detachable Shoulder Bag



Made in China

All boxes shown sold separately

Paper Crafting

6822AG ARTBIN® ROLLING TOTE Gray Pattern

- Collapsible tote with carrying handles
- Retractable handle extends to 34.5" from the ground
- Constructed of durable, fashionable, weather resistant poly canvas
- Lightweight (under 3.5 lbs.)
- 18" x 13.75" x 13.75"



2 Mesh pockets on the back

Completely collapsible

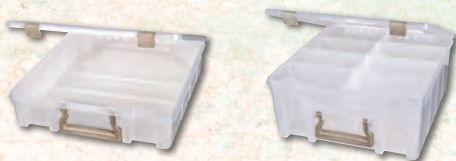
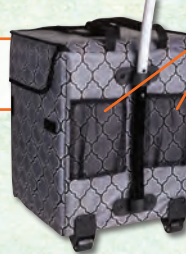

Sized to hold all Super Satchel™ Standard, Slim, Double Deep™, Semi Satchel™ and small storage boxes

6822AJ ARTBIN® ROLLING TOTE 3 PACK

- PDQ included
- 13.5" x 14.5" x 18.5"



Made in China

SLIM LINE™ BOXES

- Molded in crystal clear impact resistant styrene

SLIM LINE™ 4 X 4 BOXES - 2 PACK

6900AG

6906AG

6910AG

- Slim design easily fits in totes, pockets and other ArtBin® products
- 4.25" x 3.75" x .625"



6907AB 10 COMPARTMENT
Clear

- Great for beads, diamond dotz, jewelry supplies and other small supplies
- 7.375" x 3.625" x .6875"



6811AG SLIM LINE™ MAGNETIC BOX
Clear

- Magnetic base holds cutting blades and tools
- 7.375" x 3.625" x .6875"

MAGNETIC BASE!



6902AG SLIM LINE™ BOX
Clear

- Great for pens, pencils and other small items
- 7.375" x 3.625" x .6875"



6900AB PENCIL/UTILITY BOX
Charcoal

- Perfect for organizing pencils, markers and cutting tools
- Foam pads protect pencil points and sharp blade tips
- Molded in tinted translucent polypropylene
- 12.38" x 4.875" x 1.75"

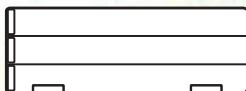

Fits in the
Solutions™ Cabinets
(Pgs 22, 35, 43, 54)

Paper Crafting

BIN PACKS

- Fits in a Super Satchel™
- Can hang on a peg wall
- Stackable with tight fitting lids



6969AG 3 PACK BINS Clear Lids and Bases

- 4.25" x 3.25" x 3"



Made in China



6971AG 4 PACK BINS Clear Lids and Bases

- 3.12" x 9.82" x 3.02"



Made in China

SUPER SATCHEL™ WITH CLEAR BINS

6967AG Clear lids & Bases

- Contains 3 short and 4 long bins
- 15.25" x 14" x 3.5"



6965AH Clear lids & Bases

- Contains 12 short bins
- 15.25" x 14" x 3.5"



Also available with
opaque bins 6965AG



Paper Crafting

6952AB CLEARVIEW™ CASE Clear

- Acid-Free polypropylene
- Lift off lid
- 5.25" x 5.25" x 1.875"



6953AB 6" X 6" BOX Clear

- Acid-Free and stackable!
- Rounded edges prevent paper edges from damage
- Slightly raised internal base allows for easier removal of contents
- 6.25" x 6.625" x 2.125"

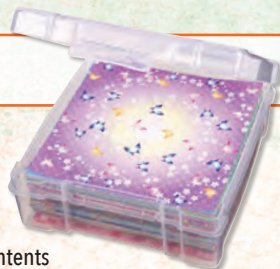

6946AB 4" X 6" PHOTO AND SUPPLY BOX Clear

- Acid-Free
- Holds up to (100) 4 x 6 photos!
- Also great as a pencil, marker or small supply storage box!
- 6.625" x 4.75" x 1.125"



QUICK VIEW™ WITH REMOVABLE BINS

- Removable bins ideal for the storage of small supplies
- Lid design locks bins in place when closed, no migration of supplies
- Heavy duty handle and latches designed for portability



6873AG QUICK VIEW™ WITH REMOVABLE BINS

- 15 Removable bins
- 8.125" x 13" x 2.375"



6874AG QUICK VIEW™ WITH REMOVABLE BINS

- 13 Removable bins
- 16.5" x 13" x 2.5"



6877AG DOUBLE-SIDED QUICK VIEW™ WITH REMOVABLE DIVIDERS

- 24 Removable dividers create up to 30 compartments
- Two sided craft storage
- 12.5" x 10.5" x 3.25"



6876AG QUICK VIEW™ WITH REMOVABLE DIVIDERS

- 22 Compartments and 18 removable dividers
- 12.5" x 10.5" x 2.25"



Paper Crafting

6838AG SKETCH BOARD
Gray and Black

- Fits 9" x 12" pad in 2 places
- Internal pencil and supply storage
- 16" L x 11.5" W x 1.5" H



Made in China



6963AG CRAFT CADDY
Black and Gray

- Tool rack slots for quick, easy access to frequently used tools
- Drawer access from either side for storing smaller items
- 16.625" x 10.25" x 6.875"



DELUXE SERIES: THE ULTIMATE STORAGE UNIT!

- Lid and base each have separate access
- (2) Side bins with dividers allow for multiple storage options
- **Acid-Free** and stackable!
- 17.25" x 16.75" x 5"

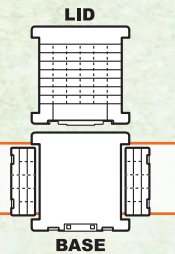

6981AB DIVIDED LID / 1 COMPARTMENT BASE Clear

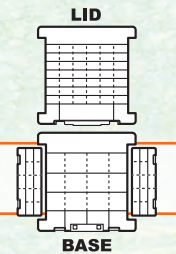

6982AB DIVIDED LID / DIVIDED BASE Clear



SOLUTIONS™ CABINETS

- Space efficient cabinet comes with (2) **3900AB** Divided and (1) **3901AB** Open Core Solutions™ boxes!
- Secure front "door" holds boxes in place
- Additional space in lid for supplies or will hold up to 2 additional Solutions boxes (sold separately)
- Secure latch on lid and comfort grip handle
- 14.5" x 6.5" x 10.5"



6994AA
Aqua Mist



6994AB
White

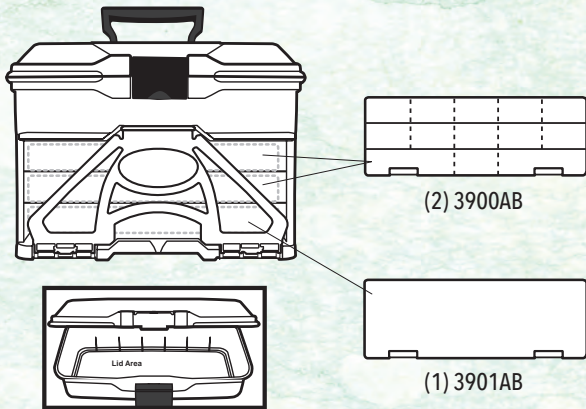

Paper Crafting

STORE-IN-DRAWER™ CABINETS

- Drawers can easily be divided for added storage (dividers sold separately)
- Great for small paint tubes, jewelry making supplies and more!
- Wall mountable: 14.375" x 6" x 8.75"

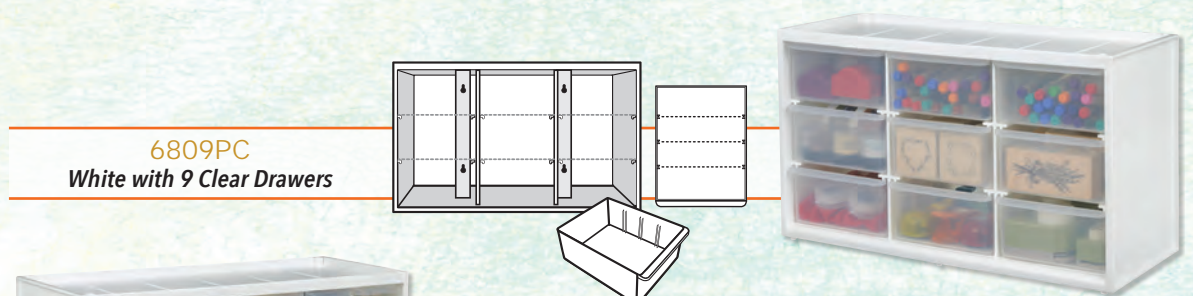

6809PC
White with 9 Clear Drawers

Made in Malaysia



Made in Malaysia

6830PC
White with 30 Clear Drawers

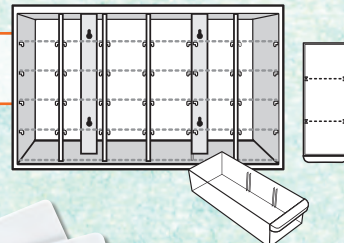

6810PC **DIVIDERS**
Clear

- Fits 6830PC 30 drawer cabinet
- 10 Dividers per pack



Stackable!

SEMI SACHEL™

- Customize using dividers for pre-cut fabrics and fat quarters!
- Compatible with ArtBin® accessories: **6826AG**, **6828AG**, **6939AB** and **6951AB**
- 3 Removable dividers to customize space
- **Acid-Free** and size: 15.25" x 8" x 6.25"



6925AB
Removable Dividers, Clear



6925AA
Aqua Mist Handle & Latch



Sewing & Quilting

SUPER SACHEL™ Standard

- Excellent for storing fat quarters, quilt blocks or bulk supplies
- Compatible with ArtBin® accessories: **6820AG** and **6951AB**
- 15.25" x 14" x 3.5"



Fits in the
Super Satchel™ Cube



Super Satchel™
boxes are designed
to stack together.

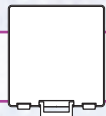

6955AB
1 Compartment, Clear



6955AA
Aqua Mist



6955RK
Blush



6955RJ
Mint

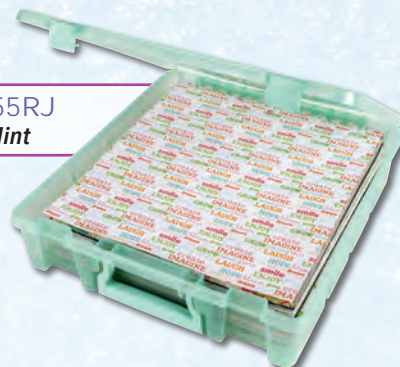



Super Satchel™ boxes are designed to stack together.



Fits in the Super Satchel™ Cube

DOUBLE DEEP™

- Use "Open Core" (without dividers) for paper and albums or customize up to 8 compartments for multiple storage options including fabric, scissors, thread and more!
- Compatible with ArtBin® accessories: **6826AG**, **6828AG**, **6901AB**, **6939AB** and **6951AB**
- **Acid-Free** and size: 15.25" x 8" x 6.25"

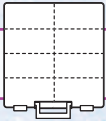

6990AB
Clear



6990AA
Aqua Mist



6990RK
Rose Gold Handle & Latches



6990RH
Aqua Mist Handle & Latches



Removable tray



Removable tray



6899AC **DOUBLE DEEP™ WITH TRAY**
CLEAR

- Customize from open core up to 8 compartments, plus tray
- 15.25" x 14" x 6.25"



Sewing & Quilting

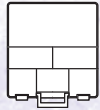

9001AB SUPER SACHEL™
Standard - Divided, Clear

- 6 Fixed divided compartments
- 15.25" x 14" x 3.5"



9100AB SUPER SACHEL™
Slim - 1 Compartment, Clear

- Excellent for storing quilt blocks, quilt tops and fat quarters
- 15.25" x 14" x 2"

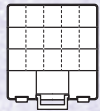

9007AB SUPER SACHEL™
Standard - Removable Dividers, Clear

- 6 Fixed compartments and 12 removable dividers make custom storage possibilities for any number of supplies
- 15.25" x 14" x 3.5"

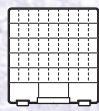

9101AB SUPER SACHEL™
Slim - Removable Dividers, Clear

- 8 Fixed compartments and 20 removable dividers
- Excellent for all small sewing/quilting supplies
- 15.25" x 14" x 2"



BIN PACKS

- Fits in a Super Satchel™
- Can hang on a peg wall
- Stackable with tight fitting lids



6969AG 3 PACK BINS
Clear Lids and Bases

- 4.25" x 3.25" x 3"



Made in China



6971AG 4 PACK BINS
Clear Lids and Bases

- 3.12" x 9.82" x 3.02"



Made in China



SUPER SACHEL™ WITH CLEAR BINS

6967AG
Clear lids & Bases

- Contains 3 short and 4 long bins
- 15.25" x 14" x 3.5"



6965AH
Clear lids & Bases

- Contains 12 short bins
- 15.25" x 14" x 3.5"



Also available with opaque bins 6965AG





Made in China

6855SC **SUPER SACHEL™ CUBE**
White

CUSTOMIZE WITH ANY FULL SIZE SUPER SACHEL™ BOXES



- Each Super Satchel Cube™ comes with 6 sets of rails which allows you to store Slim, Standard, and Double Deep™ Super Satchel™ boxes (**boxes not included**)
- Interior walls are pre-drilled with a series of holes to allow customization of rail heights
- Assembly required; box size: 15.5" x 16.75" x 15.625"



6856SW **CUBE CASTERS**



A SET OF 4 CASTERS SUPPORTS A TOTAL WEIGHT OF 225 LBS. (INCLUDING CUBE AND SUPPLIES)

SUPER SACHEL™ SYSTEM ACCESSORIES



Shown with all 20mm spools

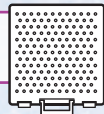

9002AB **THREAD BOX**
Clear

- Includes 2 removable thread trays
- 2 Spool trays with a combined total of 104 pegs offers the capacity to hold up to (224) 20mm spools, (108) 32mm spools or (30) 45mm spools
- Clear to easily view supplies
- 15.25" x 14" x 3.5"

Shown with a variety of 20mm, 32mm and 45mm spools



Made in China

6820AG **THREAD STORAGE TRAY**
White

- Holds 21 spools of thread
- Sturdy and stylish construction
- Wall mountable

Fits 2 inside Super Satchel™ 6955AB and 1 in Super Satchel™ Semi 6925AB!



Made in China

6901AB **CONE THREAD TRAY**
White

- Sturdy base with easy to insert "prongs" holds a minimum of 25 and up to 50 cone thread spools



Fits inside Super Satchel™ Double Deep™ 6990AB



Sewing & Quilting

SEW-LUTIONS™ BOXES

NEW!

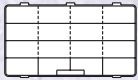

6980AG SOLUTIONS™ XL BOX
CLEAR

- 7 Fixed compartments, 9 removable dividers
- 15.25" x 8.875" x 3"



6840JN FLOSS FINDER
Clear

- 6 Fixed compartments with 12 removable dividers
- **Acid-Free** shatterproof box with no-spill latches
- 10.75" x 7.375" x 1.75"

Sewing & Quilting

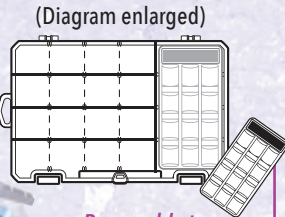

Removable tray with Magnetic strip

Magnetic strip on tray for pins and needles!

6911AB BOBBIN AND SUPPLY BOX
Clear

- Removable tray holds 30 bobbins!
- 4 Compartments with removable dividers for small supplies
- 10.75" x 7.375" x 1.75"



7003AB SEWING SUPPLY STORAGE
Clear

- Removable tray holds most popular sizes and shapes of sewing and quilting thread
- 16.5" x 9.75" x 3.25"

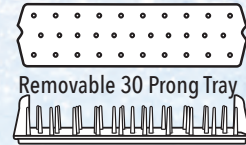
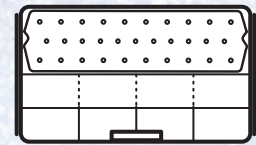

Removable 30 Prong Tray



8156AB LARGE BOBBIN BOX
Clear

- Sized to hold standard and class "M" bobbins
- **Acid-Free** polypropylene to easily view contents
- 8.25" x 4.375" x 1.25"



8155AB BOBBIN BOX
Clear

- Easily holds 30 bobbins.
- **Acid-Free** polypropylene
- 5.875" x 3.5" x 1.3125"

SLIM LINE™ BOXES

- Molded in crystal clear impact resistant styrene
- Slim design easily fits in totes, pockets and other Artbin® Products

SLIM LINE™ 4 X 4 BOXES - 2 PACK

6900AG

6906AG

6910AG

- Slim design easily fits in totes, pockets and other ArtBin® products
- 4.25" x 3.75" x .625"



6907AB 10 COMPARTMENT
Clear

- Great for pins, needles, buttons and other small supplies
- 7.375" x 3.625" x .6875"



6902AG SLIM LINE™ BOX
Clear

- Great for pens, pencils and other small items
- 7.375" x 3.625" x .6875"



6811AG SLIM LINE™ MAGNETIC BOX
Clear

- Magnetic base holds cutting blades and tools
- 7.375" x 3.625" x .6875"

MAGNETIC BASE!



6905AB SLIM LINE™ MAGNETIC BOX
Clear Raspberry

- Magnetic base holds pins, needles, bobbins and scissors
- 7.375" x 3.625" x .6875"

MAGNETIC BASE!



Sewing & Quilting



6952AB CLEARVIEW™ CASE
Clear

- Acid-Free
- Lift-off lid
- 5.25" x 5.25" x 1.875"

Lift off lid

6947ZZ PHOTO & CRAFT SUPPLY ORGANIZER SET CLEAR

- Great for 4" x 6" photos, cards, fabric, floss and much more
- 7.5" x 7.2" x 5.2"



6953AB 6" X 6" BOX
Clear

- Acid-Free and stackable!
- Slightly raised internal base allows easier removal of contents
- 6.25" x 6.625" x 2.125"

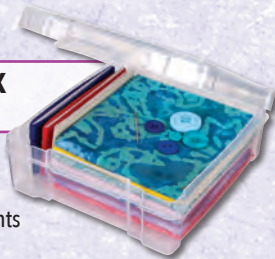

6815AG MINI SIDEKICK™
Clear

- Great bulk storage box for supplies
- Supplies easily visible
- Lockable
- 11" x 5.5" x 7"



6890AG SMALL PROJECT BOX
Clear

- Lift-out tray for small items
- Great compact size for small projects and children
- 9" x 5.5" x 6.75"



8408AB SIDEKICK™
Clear

- Secure latch with side opening lid
- Additional storage in top of lid
- Generous bulk storage beneath tray
- 15" x 10" x 7.75"

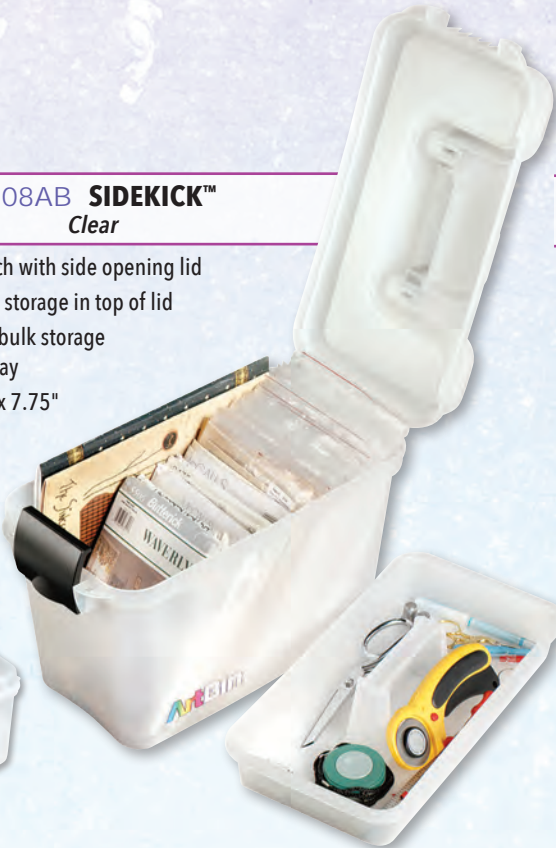

6918AH 17" TWIN TOP
Clear

- Additional compartments in lid store small items
- Sturdy lockable latch keeps supplies secure
- 17" x 8.5" x 8.5"



17"

Sewing & Quilting



6999AB FABRIC STRIP CASE
Clear

- Reduce wrinkles by storing your Fabric Strips flat
- Fits standard 2.5" x 48" fabric strips
- 24" x 4.75" x 3.5"

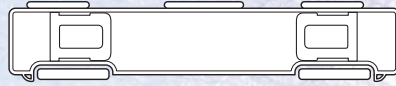

*Adjustable pressure clips
hold strips in place*

*Also Available in a
Fabric Strip Case PDQ*



SOLUTIONS™ CABINETS

- Space efficient cabinet comes with (2) **3900AB** Divided and (1) **3901AB** Open Core Solutions™ boxes!
- Secure front "door" holds boxes in place
- Additional space in lid for supplies or will hold up to 2 additional Solutions boxes (sold separately)
- Secure latch on lid and comfort grip handle
- 14.5" x 6.5" x 10.5"



6994AA
Aqua Mist

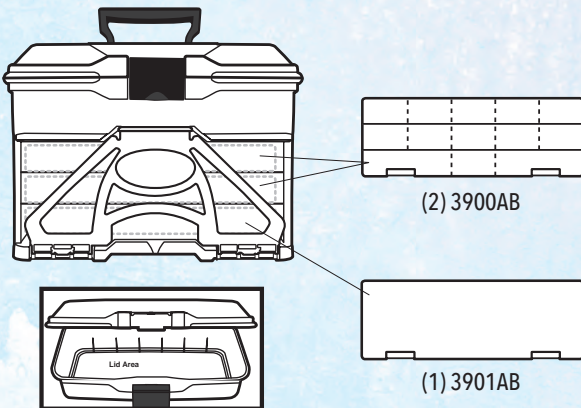

(2) 3900AB

(1) 3901AB



6994AB
White

Sewing & Quilting

DELUXE SERIES: THE ULTIMATE STORAGE UNIT!

- Lid and base each have separate access
- 2 Side bins with dividers allow for multiple storage options
- **Acid-Free** and stackable!
- 17.25" x 16.75" x 5"

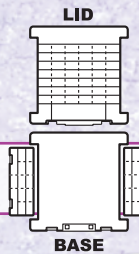

6981AB **DIVIDED LID / 1 COMPARTMENT BASE** Clear

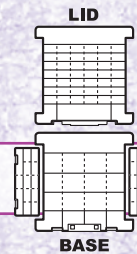

6982AB **DIVIDED LID / DIVIDED BASE** Clear



Sewing & Quilting

STORE-IN-DRAWER™ CABINETS

- Drawers can easily be divided for added storage (dividers sold separately)
- Conveniently stack both styles
- Wall mountable: 14.375" x 6" x 8.75"

6809PC
White with 9 Clear Drawers

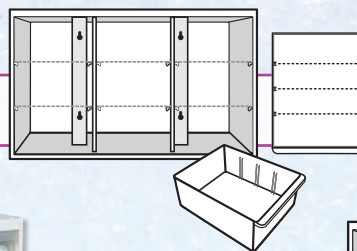

Made in Malaysia



Made in Malaysia

6830PC
White with 30 Clear Drawers

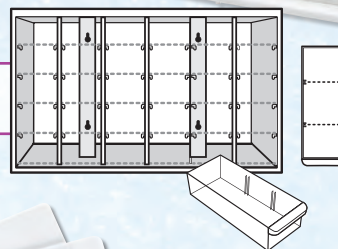

6810PC **DIVIDERS**
Clear

- Fits 6830PC 30 drawer cabinet
- 10 Dividers per pack



Stackable!

6922SA TOTE EXPRESS™ Black and Gray

Complete unit: 18" x 13" x 30.5"

Top Unit: 18" x 13" x 16.25"

- 26 Individual loops on inside cover for pencils, scissors, etc.
- Large back pocket holds up to 12" x 12" books, papers & projects
- Shoulder strap w/shoulder pad to transport the top unit separately

Bottom Unit: 18" x 13" x 14.25"

- Large, open base easily accommodates bulkier supplies
- Solid wall inserts in both top and bottom units
- Double reinforced side handles for secure lifting of bottom unit
- Transport with locking 2 stage handle and sturdy double skate wheels



Detachable Shoulder Bag



Made in China

All boxes shown sold separately

6822AG ARTBIN® ROLLING TOTE Gray Pattern

- Collapsible tote with carrying handles
- Retractable handle extends to 34.5" from the ground
- Constructed of durable, fashionable, weather resistant poly canvas
- Lightweight (under 3.5 lbs.)
- 18" x 13.75" x 13.75"



2 Mesh pockets on the back
Completely collapsible

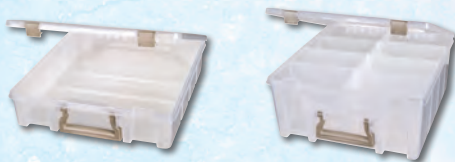

Sized to hold all Super Satchel™ Standard, Slim, Double Deep™, Semi Satchel™ and small storage boxes

6822AJ ARTBIN® ROLLING TOTE 3 PACK

- PDQ included
- 13.5" x 14.5" x 18.5"



Made in China

Sewing & Quilting



6840JN FLOSS FINDER
Clear

- 6 Fixed compartments with 12 removable dividers
- Clear **Acid-Free** shatterproof box with no-spill latches
- 10.75" x 7.375" x 1.75"

15"



6962AB DIVIDED BASE W/LIFT-OUT TRAY
Clear

- Lift-out tray custom designed to fit over divided base to prevent migration of supplies
- Lower level has both fixed and removable dividers
- Comes with 16 removable dividers
- 15" x 3.5" x 14.5"

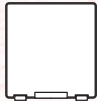

9100AB SUPER SATCHEL™
Slim - 1 Compartment, Clear

- Excellent for safely storing multiple projects, hoops and supplies
- 15.25" x 14" x 2"

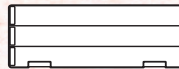

Fits in the
Solutions™ Cabinets
(Pgs 22, 35, 43, 54)

6932AB HOOK & NEEDLE NOOK™
Periwinkle

- Divided compartments conveniently separate needles
- 12.38" x 4.875" x 1.75"



6875AG HOOK & NEEDLE FOLIO
Black & Gray

- Stitched elastic pockets will hold knitting needles, crochet hooks, and bobbins safely in place
- 2 Envelope top pockets for additional supplies
- Full-sized pocket for brochures, rulers and longer items
- Completely zips closed for secure transport
- 15.125" x 6.625" x 1.375"

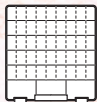

9101AB SUPER SATCHEL™
Slim - Removable Dividers, Clear

- 8 Fixed compartments and 20 removable dividers
- Excellent for floss cards, needles, scissors and more
- 15.25" x 14" x 2"



Made in China

YARN DRUM™

- Holds up to 8 standard sized skeins of yarn!
- Yarn in use can easily be removed from tote through lid
- Textured PVC base keeps contents dry on wet surfaces
- 12" Dia. x 12.75"

Transport 3 Different Ways!



All Made in China

6804SA
Pattern



6805SA
Raspberry



6807SA
Periwinkle



MINI YARN DRUM™

- Holds one standard sized skein of yarn
- Yarn can be easily removed from the tote through the lid
- Textured base and fashionable weather resistant poly canvas keeps contents dry and clean
- Front mesh pocket can hold hooks, needles or a cell phone
- Swivel clip
- 5.75" Dia. x 9.5"



Size comparison

6824AG
Pattern



Made in China

6831AG
Raspberry



Made in China



Needle Arts



Anti-Tarnish is EXCLUSIVE to ArtBin®. It provides safe, long-term protective storage for sterling silver and other non-ferrous metal items. The proprietary Anti-Tarnish additive forms a harmless protective layer around the item's surface preventing tarnishing up to 5 years.

ANTI-TARNISH BOXES



6983AG
Clear

- 3 Fixed compartments, 9 removable dividers
- 12.38" x 4.875" x 1.75"

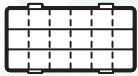

Fits in the
Solutions™ Cabinets
(Pgs 22, 35, 43, 54)



6847AG
Clear

- 6 Fixed compartments, 12 removable dividers
- 10.75" x 7.375" x 1.75"

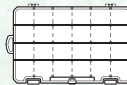

DIVIDER PACKS

3712AG

- Fits 6983AG - 12/pk

4715AG

- Fits 6847AG - 12/pk

5715AG

- Fits 6857AG & 6865AG - 12/pk



6944AG
Clear

- 4 Fixed compartments, 12 removable dividers
- 10.75" x 7.375" x 1.75"



Large Side
Compartment



6865AG
Clear

- 8 Fixed compartments, 20 removable dividers
- 15.25" x 14" x 2"

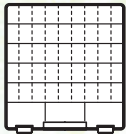

Fits in the
Super Satchel™ Cube



6857AG
Clear

- 4 Fixed compartments, 18 removable dividers
- 14.125" x 9" x 2"



Beadling & Jewelry

Bead tray included!



6962BB QUICK VIEW™ BEAD BOX
Clear

- Tray designed to prevent bead migration
- Anti-Tarnish removable dividers
- 15" L x 3.5" W x 14.5" H

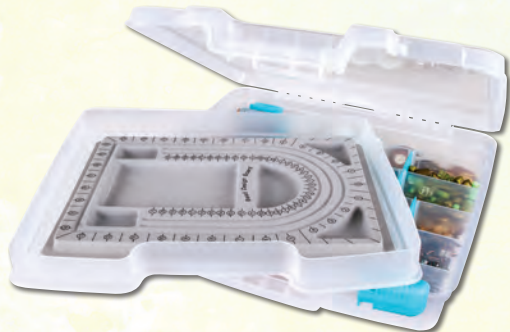

Enjoy the convenience of all your beading supplies stored in one product!



ANTI-TARNISH TWISTERZ™



- Twist to close lids
- Zerust™ is molded into each Twisterz
- Stack and lock design

6947AT

1.4 fl oz./41.4 ml.
Small/Short

6948AT

3.4 fl oz./100.5 ml.
Small/Tall



Made in China



Made in China

6945AT

3.9 fl oz./115.3 ml.
Large/Short

6946AT

9 fl oz./266.1 ml.
Large/Tall



Super Satchel™ boxes are designed to stack together.



Fits in the Super Satchel™ Cube

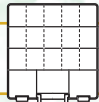

9007AB SUPER SACHEL™
Standard - Removable Dividers, Clear

- 6 Fixed compartment, 12 removable dividers provide
- Secure latches and carry handle
- 15.25" x 14" x 3.5"



9101AB SUPER SACHEL™
Slim - Removable Dividers, Clear

- 8 Fixed compartments, 20 removable dividers
- 15.25" x 14" x 2"

STORE-IN-DRAWER™ CABINETS

- Drawers can easily be divided for added storage (dividers sold separately)
- Great for small paint tubes, jewelry making supplies and more!
- Wall mountable: 14.375" x 6" x 8.75"

6809PC
White with 9 Clear Drawers

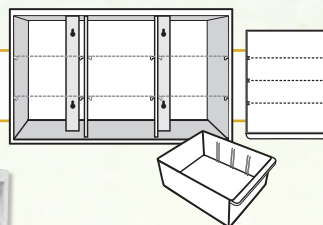

Made in Malaysia

6830PC
White with 30 Clear Drawers

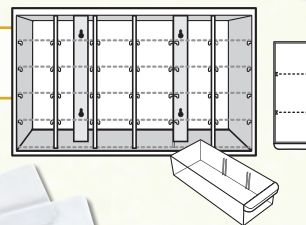

Made in Malaysia

6810PC DIVIDERS
Clear

- Fits 6830PC 30 drawer cabinet
- 10 Dividers per pack



Stackable!

BIN PACKS

- Fits in a Super Satchel™
- Can hang on a peg wall
- Stackable with tight fitting lids



6969AG 3 PACK BINS
Clear Lids and Bases

- 4.25" x 3.25" x 3"



Made in China



6971AG 4 PACK BINS
Clear Lids and Bases

- 3.12" x 9.82" x 3.02"



Made in China

SUPER SACHEL™ WITH CLEAR BINS

6967AG
Clear lids & Bases

- Contains 3 short and 4 long bins
- 15.25" x 14" x 3.5"



6965AH
Clear lids & Bases

- Contains 12 short bins
- 15.25" x 14" x 3.5"



Also available with opaque bins **6965AG**

6890AG SMALL PROJECT BOX
Clear

- Lift-out tray for small items
- Great compact size for small projects and children
- 9 x 5.5 x 6.75"



Beading & Jewelry

QUICK VIEW™ WITH REMOVABLE BINS

- Removable bins ideal for the storage of small supplies
- Lid design locks bins in place when closed, no migration of supplies
- Heavy duty handle and latches designed for portability



6873AG QUICK VIEW™ WITH REMOVABLE BINS

- 15 Removable bins
- 8.125" x 13" x 2.375"



6874AG QUICK VIEW™ WITH REMOVABLE BINS

- 13 Removable bins
- 16.5" x 13" x 2.5"



6877AG DOUBLE-SIDED QUICK VIEW™ WITH REMOVABLE DIVIDERS

- 24 Removable dividers create up to 30 compartments
- Two sided bead storage
- 12.5" x 10.5" x 3.25"



6876AG QUICK VIEW™ WITH REMOVABLE DIVIDERS

- 22 Compartments, 18 removable dividers
- 12.5" x 10.5" x 2.25"



SLIM LINE™ BOXES

- Molded in crystal clear impact resistant styrene
- Slim design easily fits in totes, pockets and other Artbin® Products

**SLIM LINE™
4 X 4 BOXES - 2 PACK**

6906AG

- 4.25" x 3.75" x .625"



6910AG



**6907AB 10 COMPARTMENT
Clear**

- Great for beads, wires, jewelry material and other small supplies
- 7.375" x 3.625" x .6875"



PRISM™ SERIES BOXES

- Crystal clear boxes offer easy viewing of supplies
- Great for beading and small supplies

918AB

- 18 Fixed compartments
- 8.875" x 4.875" x 1.375"

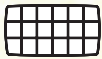

1118AB

- 18 Fixed compartments
- 11.5" x 6.625" x 1.75"



**8924AB SLIDE 'N STORE™
Clear**

- 24 Fixed, divided compartments
- Molded in crystal clear styrene for easy viewing of all supplies
- Sliding lid with "catch" allows for easy access to supplies without sliding completely off
- Flush lid keeps supplies from "migrating"
- 10.5" x 8.25" x 1.5"



Beading & Jewelry

SOLUTIONS™ CABINETS

- Space efficient cabinet comes with (2) **3900AB** Divided and (1) **3901AB** Open Core Solutions™ boxes!
- Secure front "door" holds boxes in place
- Additional space in lid for supplies or will hold up to 2 additional Solutions boxes (sold separately)
- Secure latch on lid and comfort grip handle
- 14.5" x 6.5" x 10.5"



6994AA
Aqua Mist

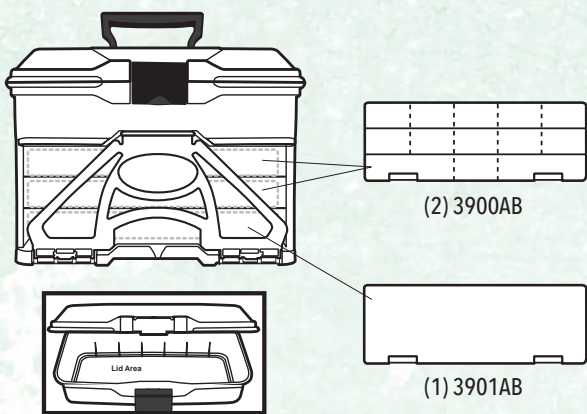

6994AB
White



Made In China

6855SC **SUPER SATCHEL™ CUBE**
White

CUSTOMIZE WITH ANY FULL SIZE SUPER SATCHEL™ BOXES

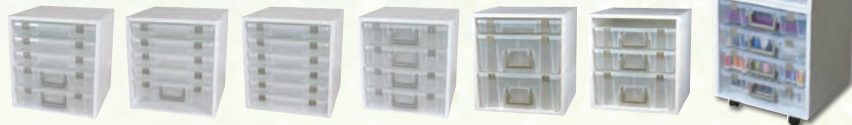

- Each Super Satchel Cube™ comes with 6 sets of rails which allows you to store Slim, Standard, and Double Deep™ Super Satchel™ boxes (**boxes not included**)
- The Cube's interior walls are pre-drilled with a series of holes to allow customization of rail height and easy access to your supplies!
- Assembly required
- 15.5" x 16.75" x 15.625"

6856SW **CUBE CASTERS**



A SET OF 4 CASTERS SUPPORTS A TOTAL WEIGHT OF 225 LBS. (INCLUDING CUBE AND SUPPLIES)

INDEX

NEW FOR 2020 2-5

Vinyl Storage Rack™	2
Desktop Organizer	2
Vinyl Storage Tower	3
Solutions™ Box	4
Double Deep™ with Tray	4
3 and 4 Bin Packs	5
Super Satchel™ with Bins	5

SUPER SACHEL™ SYSTEM 6-11

Super Satchel™ Story	6
Semi Satchel™	7
Super Satchel™ Standard	7
Double Deep™	8
Double Deep™ with Tray	8
Super Satchel™ Cube and Casters	8
Super Satchel™ Boxes	9
3 and 4 Bin Packs	9
Super Satchel™ with Bins	9
Thread Storage Tray	10
Paint Storage Tray	10
Ribbon Storage Tray	10
Cone Thread Tray	10
Marker Storage Tray and Storage	10
Bottle Storage Tray and Storage	10
Tote Express™	11
Artbin® Rolling Tote	11
Artbin® Rolling Tote 3 Pack	11

STORAGE NECESSITIES 12-23

Quick View™ Carrying Cases	12-13
Quick View™ Removable Bins	14
Sidekick™ Cube with Paint Palette	15
Paint Storage Palette Pack	15
Sidekick™ Cube with Open Tray	15
Mini Sidekick™	15
Sidekick™	15
Lift-Out Tray Boxes	16
Small Project Box	16
17" Twin Top	16
Slim Line™ 4" x 4" Boxes-2 Packs	17
Slim Line™ 10 Compartment	17
Prism™ Series Boxes	17
Solutions™ Boxes	18-19
IDS™ Boxes	19
3 and 4 Bin Packs	20
Super Satchel™ with Clear Bins	20
4" x 6" Photo & Supply Box	21
Photo & Craft Supply Organizer Set	21
Twisterz™	21
Twisterz™ 3 Packs	21
Slime Box	22

Solutions™ Cabinets	22
Deluxe Series	23
12" x 12" Storage Boxes	23

PAPER CRAFTING 24-35

Vinyl Storage Rack	24
Vinyl Storage Tower	24
Desktop Organizer	24
Semi Satchel™	25
Super Satchel™ Standard	25
Double Deep™	26
Double Deep™ with Tray	26
Super Satchel™	27
Super Satchel™ Cube and Casters	27
Paint Storage Tray	28
Ribbon Storage Tray	28
Marker Storage Tray and Storage	28
Bottle Storage Tray and Storage	29
Magnetic Die Storage Case and Sheets	29
Electronic Cartridge Storage	29
Tote Express™	30
Artbin® Rolling Tote	30
Artbin® Rolling Tote 3 Pack	30
Slim Line™ 4" x 4" Boxes-2 Packs	31
Slim Line™ 10 Compartment	31
Slim Line™ Magnetic Box	31
Slim Line™ Box	31
Pencil/Utility Box	31
3 and 4 Bin Packs	32
Super Satchel™ with Bins	32
Clearview™ Case	32
6" x 6" Box	32
4" x 6" Photo & Supply Box	32
Quick View™ Removable Bins	33
Sketch Board	34
Craft Caddy	34
Deluxe Series	34
Solutions™ Cabinets	35
Store-In-Drawer™ Cabinets	35

SEWING & QUILTING 36-45

Semi Satchel™	36
Super Satchel™ Standard	36
Double Deep™	37
Double Deep™ with Tray	37
Super Satchel™ Boxes	38
3 and 4 Bin Packs	38
Super Satchel™ with Clear Bins	38
Super Satchel™ Cube and Casters	39
Thread Box	39
Thread Storage Tray	39
Cone Thread Tray	39

Sew-lutions™ Boxes	40
Floss Finder	40
Bobbin and Supply Box	40
Sewing Supply Storage	40
Large Bobbin Box	40
Bobbin Box	40
Slim Line™ 4" x 4" Boxes-2 Packs	41
Slim Line™ 10 Compartment	41
Slim line™ box	41
Slim Line™ Magnetic Boxes	41
Clearview™ Case	42
6" x 6" Box	42
Photo & Craft Supply Organizer Set	42
Mini Sidekick™	42
Small Project Box	42
Sidekick™	42
17" Twin Top	42
Fabric Strip Case and PDQ	43
Solutions™ Cabinets	43
Deluxe Series	44
Store-In-Drawer™ Cabinets	44
Tote Express™	45
Artbin® Rolling Tote	45
Artbin® Rolling Tote 3 Pack	45

NEEDLE ARTS 46-47

Floss Finder	46
Divided Base with Lift-Out Tray	46
Super Satchel™ Boxes	46
Hook & Needle Nook	46
Hook & Needle Folio	46
Yarn Drum and Mini Yarn Drums	47

BEADING & JEWELRY 48-55

Anti-Tarnish Boxes	48-49
Quick View™ Bead Box	49
Anti-Tarnish Twisterz™	50
Super Satchel™ Boxes	50
Store-In-Drawer™ Cabinets	50
3 and 4 Bin Packs	51
Super Satchel™ with Clear Bins	51
Small project Box	51
Quick View™ Removable Bins	52
Slim Line™ 4" x 4" Boxes-2 Packs	53
Slim Line™ 10 Compartment	53
Prism™ Series Boxes	53
Slide 'N Store™	53
Solutions™ Cabinets	54
Super Satchel™ Cube and Casters	54

Beading & Jewelry

ArtBin[®]
DESIGNED WITH THE ARTIST IN MIND™



F Flambeau[®] INC.
A MEMBER OF THE NORDIC GROUP OF COMPANIES

P.O. BOX 97 15981 VALPLAST RD. MIDDLEFIELD, OH 44062 U.S.A.
PHONE (440) 632-1631 FAX (440) 632-1581 WEB www.flambeau.com

1•800•457•5252

artbin.com

F Flambeau[®] Europe

MANSTON RD. RAMSGATE, KENT, CT12 6HW, U.K.
PHONE +44•(0)•1843•854000 WEB flambeau.co.uk

+44•(0)•1843•854000

flambeau.co.uk

ArtBin[®] is a registered trademark of Flambeau Inc. All props in this catalog are shown for illustration only. Flambeau reserves the right to change product availability, model numbers, color schemes, graphics and specifications without notice. ©2020 Flambeau Inc.

9712AB (1/20) 1M